

Pottery/Shop Work Bench – Will Hobbs – 3/12/2016

Side View
6'

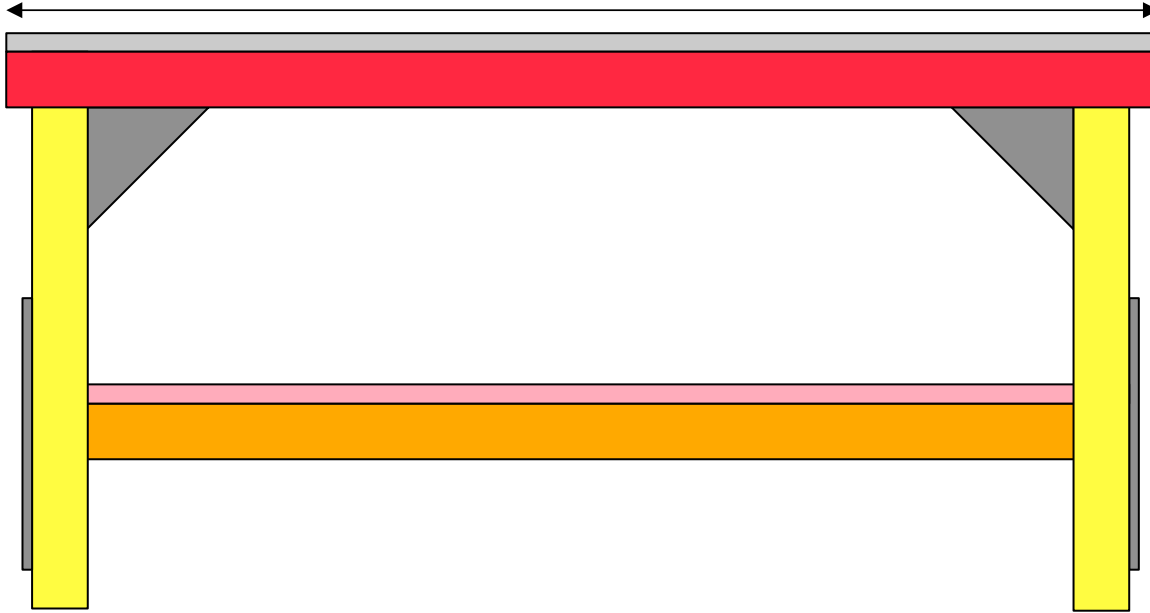

End View
2' 6"

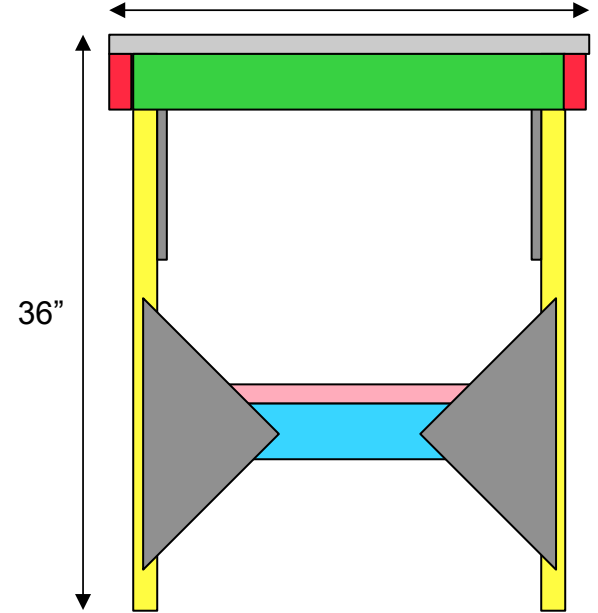

Top view (with tabletop and shelf top off)

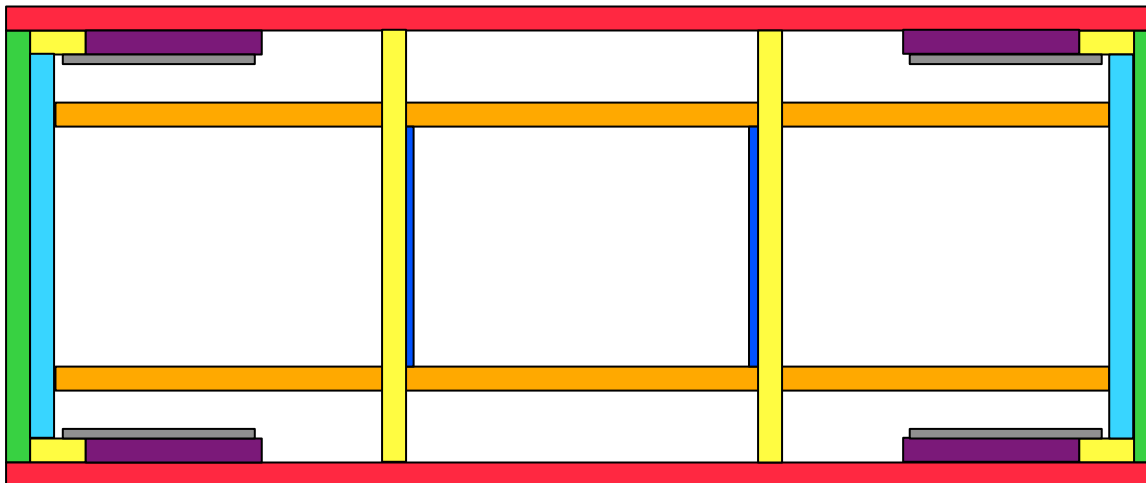

Key:
1" = 1 foot
2x4 Dimensions:
0.29" = 3.5"
0.13" = 1.5"

Four “assemblies” for easy transport

(1 x Top, 1 x Shelf, 2 x Leg)

Bottom view of top assembly

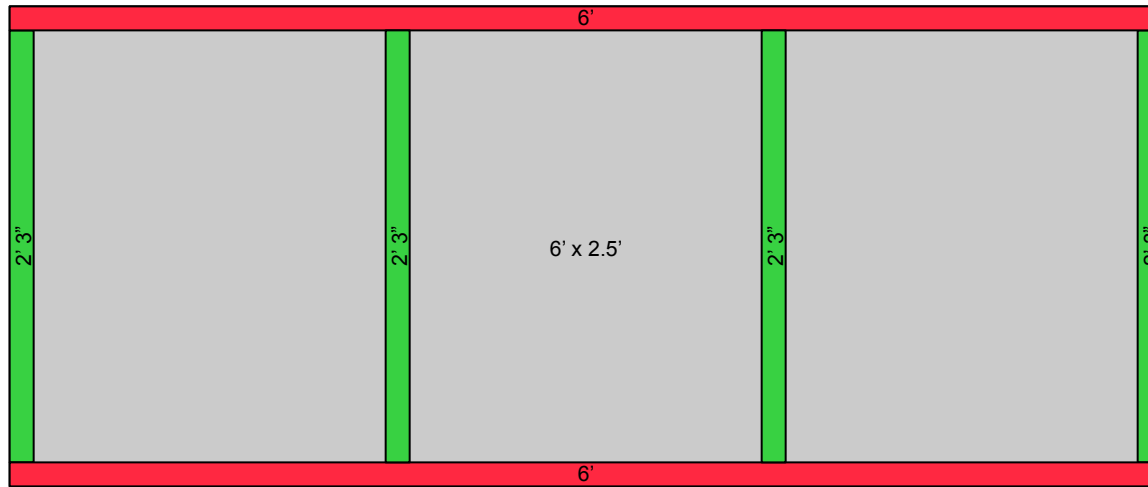

Bottom view of shelf assm.

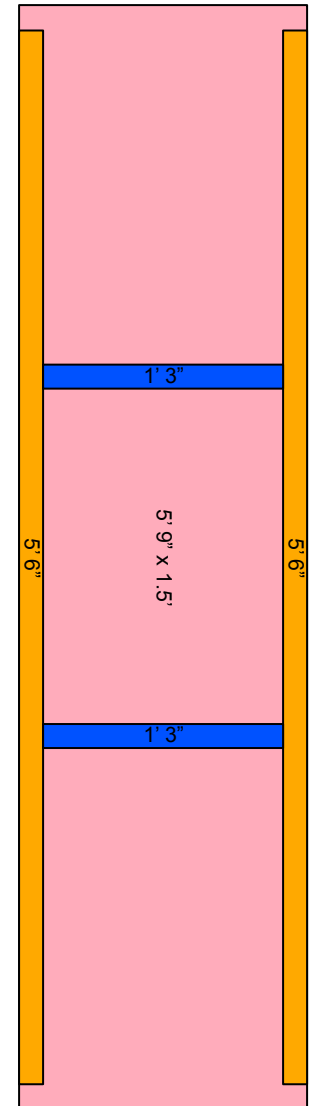

Screws:

Join all 2x4s with 2-1/2" deck screws. Pocket hole screws may be used for attaching 11" leg supports to legs.

Join plywood to 2x4s with 1-1/2" deck screws. Place screws every ~1.5' along edge and in middle supports of table and shelf tops. Use 3-4 screws per triangle piece.

Key:

1" = 1 foot

2x4 Dimensions:

0.29" = 3.5"

0.13" = 1.5"

End view of leg assm.

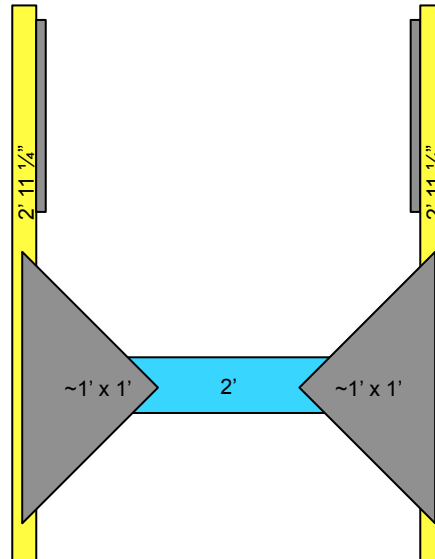

Side view of leg assm.

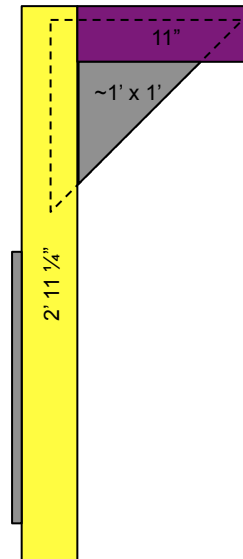

LUMBER:

7 2x4s:

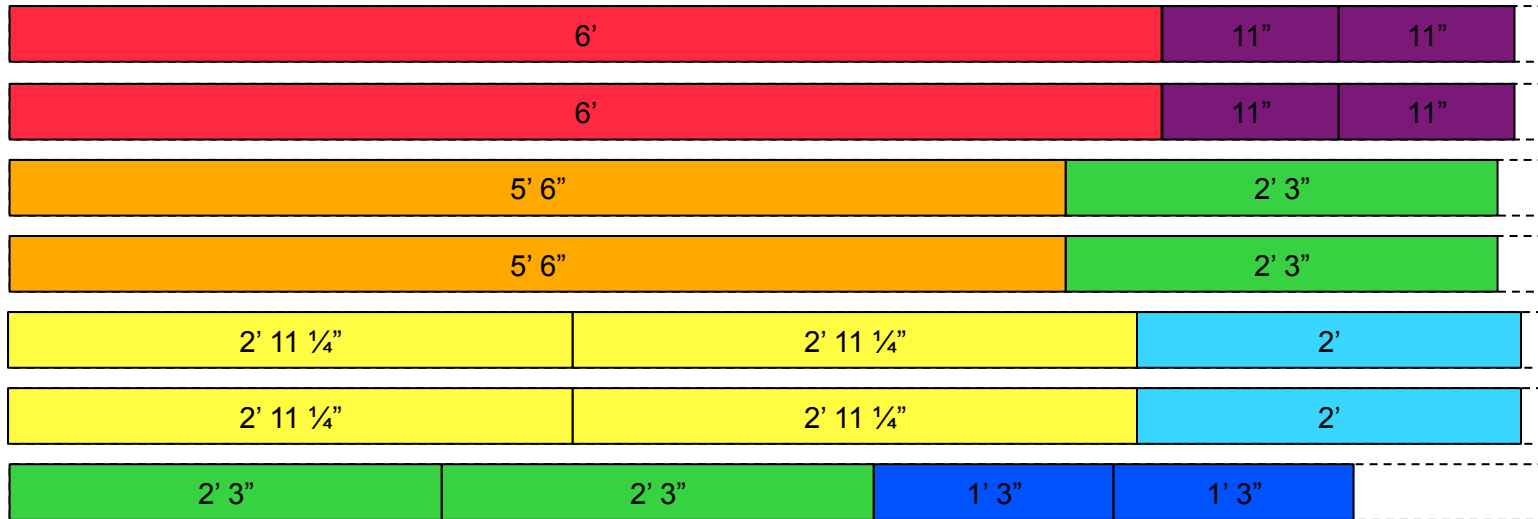

1 4x8 sheet 3/4" plywood: (dashed red cuts at store)

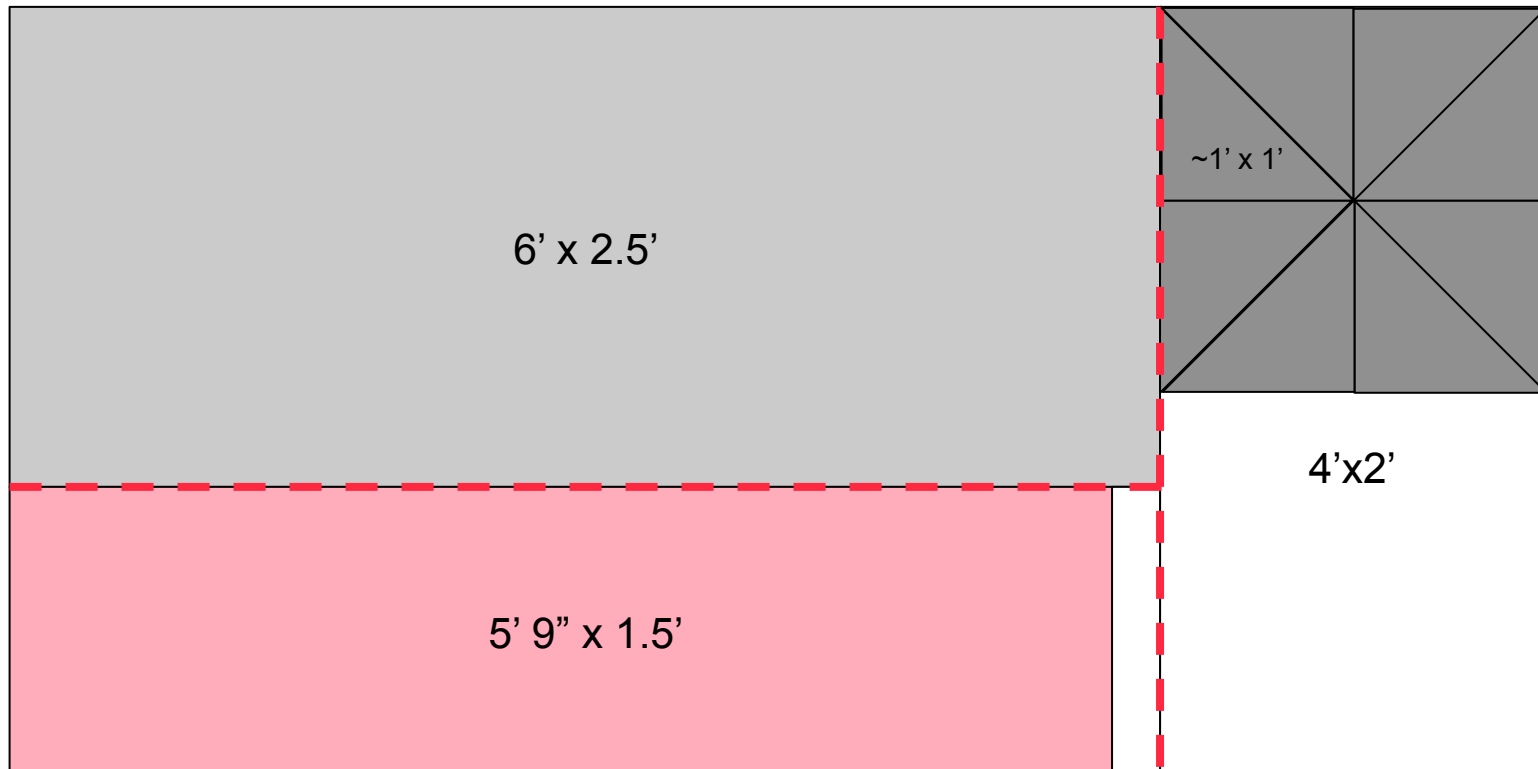

Deck Screws:

- 1 box 2-1/2"
- 1 box 1-1/2"

Key:

1" = 1 foot

2x4 Dimensions:

0.29" = 3.5"

0.13" = 1.5"